

NI600B17E6K4

1700V 600A IGBT 模块, E6封装, 内置续流二极管
1700V 600A IGBT Module, E6 Package, with FWD

特点 Features

- 1700V 沟槽栅及场截止结构
1700V Trench Gate & Field Stop Structure
- 高短路耐量
High Short Circuit Capability
- 低开关损耗
Low Switching Loss
- 高可靠性
High Reliability
- 正温度系数
Positive Temperature Coefficient



应用 Applications

- 大功率变流器
High Power Converters
- 风力发电机
Wind turbines

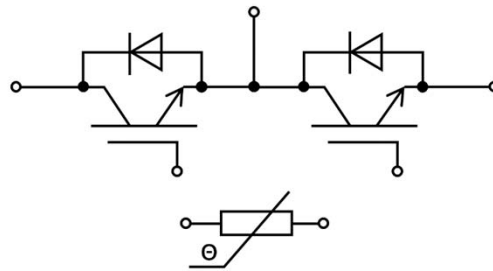

最大额定值 Maximum Rated Values

参数 Parameter	符号 Symbol	条件 Condition	数值 Value	单位 Unit
集电极-发射极电压 Collector-Emitter Voltage	V_{CES}	$V_{GE}=0V, T_{vj}=25^{\circ}C$	1700	V
集电极电流 DC Collector Current	I_C	$T_C=100^{\circ}C, T_{vj,max}=175^{\circ}C$	600	A
集电极峰值电流 Peak Collector Current	I_{CM}	$t_p=1ms$	1200	A
栅极-发射极电压 Gate-Emitter Voltage	V_{GES}		± 20	V
IGBT最大功耗 IGBT Maximum Power Dissipation	P_D	$T_C=25^{\circ}C, T_{vj,max}=175^{\circ}C$	3660	W
反向重复峰值电压 Repetitive Peak Reverse Voltage	V_{RRM}	$T_{vj}=25^{\circ}C$	1700	V
连续正向直流电流 Continuous DC Forward Current	I_F		600	A
正向重复峰值电流 Repetitive Peak Forward Current	I_{FRM}	$t_p=1ms$	1200	A
I ² t-值 I ² t-Value	I^2t	$V_R=0V, t_p=10ms, T_{vj}=125^{\circ}C$	41530	A ² s
IGBT短路耐量 IGBT Short Circuit Withstand Time	t_{psc}		10	μs
最高结温 Maximum Junction Temperature	$T_{vj(max)}$		175	$^{\circ}C$
工作结温 Operating Junction Temperature	$T_{vj(op)}$		-40~150	$^{\circ}C$
存储温度范围 Storage Temperature Range	T_{stg}		-40~125	$^{\circ}C$

IGBT特征值 IGBT Characteristics Values*1 ($T_{vj}=25^{\circ}\text{C}$ unless otherwise noted)

参数 Parameter	符号 Symbol	条件 Condition	数值 Value			单位 Unit	
			Min.	Typ.	Max.		
集电极-发射极饱和电压 Collector-Emitter Saturation Voltage	$V_{CE(sat)}$	$I_C=600\text{A}, V_{GE}=15\text{V}$	$T_{vj}=25^{\circ}\text{C}$		1.80	2.20	V
			$T_{vj}=125^{\circ}\text{C}$		2.20		
			$T_{vj}=150^{\circ}\text{C}$		2.30		
栅极-发射极开启电压 Gate-Emitter Threshold Voltage	$V_{GE(th)}$	$I_C=24\text{mA}, V_{CE}=V_{GE}$	5.5	6.0	6.5	V	
集电极-发射极截止电流 Collector-Emitter Cut-off Current	I_{CES}	$V_{CE}=1700\text{V}, V_{GE}=0\text{V}$			1	mA	
栅极-发射极漏电流 Gate-Emitter Leakage Current	I_{GES}	$V_{CE}=0\text{V}, V_{GE}=\pm 20\text{V}$	-100		100	nA	
内置栅极电阻 Internal Gate Resistance	R_{Gint}			1.2		Ω	
栅极电荷 Gate Charge	Q_G	$V_{GE}=-15\text{V}\sim+15\text{V}$		4.5		μC	
输入电容 Input Capacitance	C_{ies}	$V_{CE}=25\text{V}, V_{GE}=0\text{V}, f=1\text{MHz}$		68.5		nF	
反向传输电容 Reverse Transfer Capacitance	C_{res}			2.90		nF	
开通延迟时间 Turn-on Delay Time	$t_{d(on)}$	$I_C=600\text{A}, V_{CE}=900\text{V}, V_{GE}=\pm 15\text{V}, R_{Gon}=1\Omega, R_{Goff}=1\Omega, \text{开通} di/dt=3650\text{A/us} (T_{vj}=150^{\circ}\text{C}), \text{关断} dv/dt=4250\text{V/us} (T_{vj}=150^{\circ}\text{C}), \text{Inductive Load}$	$T_{vj}=25^{\circ}\text{C}$		160		ns
			$T_{vj}=125^{\circ}\text{C}$		180		
			$T_{vj}=150^{\circ}\text{C}$		185		
上升时间 Rise Time	t_r		$T_{vj}=25^{\circ}\text{C}$		95		ns
			$T_{vj}=125^{\circ}\text{C}$		125		
			$T_{vj}=150^{\circ}\text{C}$		130		
关断延迟时间 Turn-off Delay Time	$t_{d(off)}$		$T_{vj}=25^{\circ}\text{C}$		595		ns
			$T_{vj}=125^{\circ}\text{C}$		645		
			$T_{vj}=150^{\circ}\text{C}$		665		
下降时间 Fall Time	t_f		$T_{vj}=25^{\circ}\text{C}$		290		ns
			$T_{vj}=125^{\circ}\text{C}$		480		
			$T_{vj}=150^{\circ}\text{C}$		500		
开通损耗 Turn-on Energy Loss	E_{on}		$T_{vj}=25^{\circ}\text{C}$		145		mJ
			$T_{vj}=125^{\circ}\text{C}$		210		
			$T_{vj}=150^{\circ}\text{C}$		230		
关断损耗 Turn-off Energy Loss	E_{off}	$T_{vj}=25^{\circ}\text{C}$		115		mJ	
		$T_{vj}=125^{\circ}\text{C}$		155			
		$T_{vj}=150^{\circ}\text{C}$		170			
短路电流 Short Circuit Current	I_{SC}	$V_{GE}\leq 15\text{V}, t_{psc}\leq 10\mu\text{s}, V_{CC}=1000\text{V}, T_{vj}=150^{\circ}\text{C}$ $V_{CE,max}=V_{CES}-L_S(CE) \times di/dt$		3030		A	

*1 IGBT特征值遵从IEC 60747-9.

二极管特征值 Diode Characteristics Values*2

参数 Parameter	符号 Symbol	条件 Condition	数值 Value			单位 Unit	
			Min.	Typ.	Max.		
正向电压 Forward Voltage	V_F	$I_F=600A$	$T_{vj}=25^{\circ}C$		2.20	2.60	V
			$T_{vj}=125^{\circ}C$		2.45		
			$T_{vj}=150^{\circ}C$		2.50		
反向峰值电流 Peak Reverse Recovery Current	I_{RM}		$T_{vj}=25^{\circ}C$		335		A
			$T_{vj}=125^{\circ}C$		380		
			$T_{vj}=150^{\circ}C$		390		
反向电荷 Reverse Charge	Q_{rr}	$I_F=600A,$ $V_R=900V,$ $V_{GE}=-15V,$ $-di_F/dt=3600A/us$ ($T_{vj}=150^{\circ}C$)	$T_{vj}=25^{\circ}C$		80		uC
			$T_{vj}=125^{\circ}C$		160		
			$T_{vj}=150^{\circ}C$		185		
反向恢复损耗 Reverse Recovery Energy Loss	E_{rec}		$T_{vj}=25^{\circ}C$		40		mJ
			$T_{vj}=125^{\circ}C$		80		
			$T_{vj}=150^{\circ}C$		100		

*2 二极管特征值遵从IEC 60747-2。

负温度系数热敏电阻 NTC-Thermistor

参数 Parameter	符号 Symbol	条件 Condition	数值 Value			单位 Unit
			Min.	Typ.	Max.	
额定电阻 Rated Resistance	R_{25}	$T_{NTC}=25^{\circ}C$		5		K Ω
功耗 Power Dissipation	P_{25}	$T_{NTC}=25^{\circ}C$			10	mW
B-值 B-Value	$B_{25/50}$	$R_2=R_{25}\exp[B_{25/50}(1/T_2-1/(298,15K))]$		3380		K

封装特性 Package Properties*3

参数 Parameter	符号 Symbol	条件 Condition	数值 Value			单位 Unit
			Min.	Typ.	Max.	
IGBT 结-壳热阻 IGBT Thermal Resistance: Junction to Case	$R_{th(J-C)}$	每个IGBT/per IGBT			0.041	K/W
二极管 结-壳热阻 Diode Thermal Resistance: Junction to Case	$R_{th(J-C)}$	每个二极管/per Diode			0.060	K/W
IGBT接触热阻 IGBT Thermal Resistance: Case to Heatsink	$R_{th(C-H)}$	每个IGBT/per IGBT 硅脂导热系数 $\lambda_{grease}=1W/(m\cdot K)$		0.033		K/W
二极管接触热阻 Diode Thermal Resistance: Case to Heatsink	$R_{th(C-H)}$	每个二极管/per Diode 硅脂导热系数 $\lambda_{grease}=1W/(m\cdot K)$		0.037		K/W
绝缘耐压 Isolation Voltage	V_{isol}	RMS, f=50Hz, t=60s	3.4			kV
爬电距离 Creepage Distance	d_{cr}	端子到散热器 Terminal to Heatsink	14			mm
		端子到端子 Terminal to Terminal	13.5			mm
电气间隙 Clearance Distance	d_{cl}	端子到散热器 Terminal to Heatsink	12.5			mm
		端子到端子 Terminal to Terminal	10			mm
相对漏电起痕指数 Comparative Tracking Index	CTI		>200			
模块寄生电感 Module Stray Inductance	$L_{s, CE}$	每个桥臂/per Switch		20		nH
模块引线内阻 Module Lead Resistance, Terminal to Chip	R_{CC+EE}	每个桥臂/per Switch, $T_c=25^\circ C$		1.1		m Ω
安装扭矩 Mounting Torques	M	基板至散热器, Baseplate to Heatsink, M5	3.0		6.0	Nm
		功率端子安装, Power Terminal, M6	3.0		6.0	Nm
模块重量 Module Weight	G			345		g

*3 封装特性遵从IEC 60747-15

输出特性 IGBT
Output Characteristic IGBT
 $I_C = f(V_{CE}), V_{GE} = 15V$

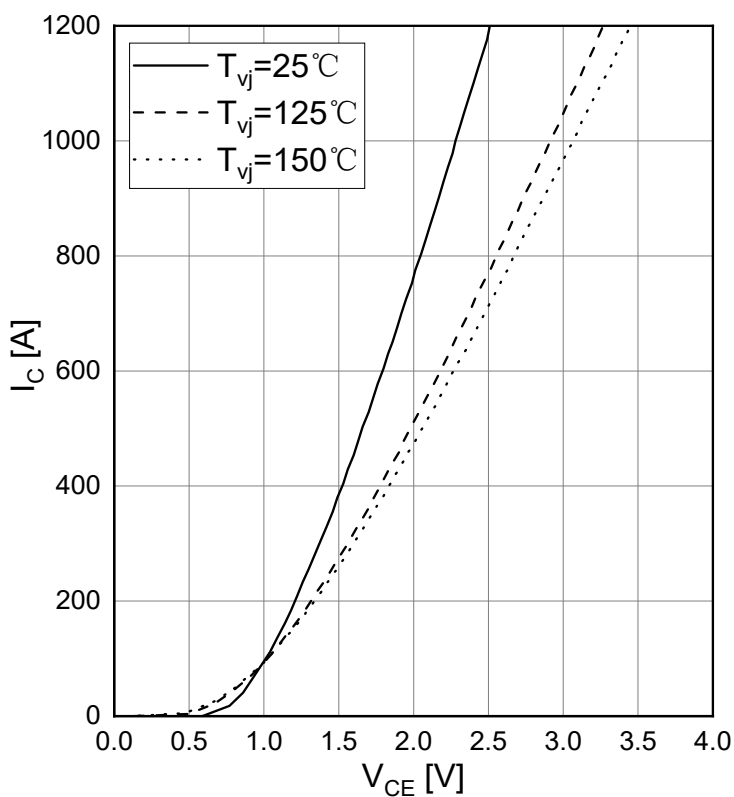

输出特性 IGBT
Output Characteristic IGBT
 $I_C = f(V_{CE}), T_{vj} = 150^\circ C$

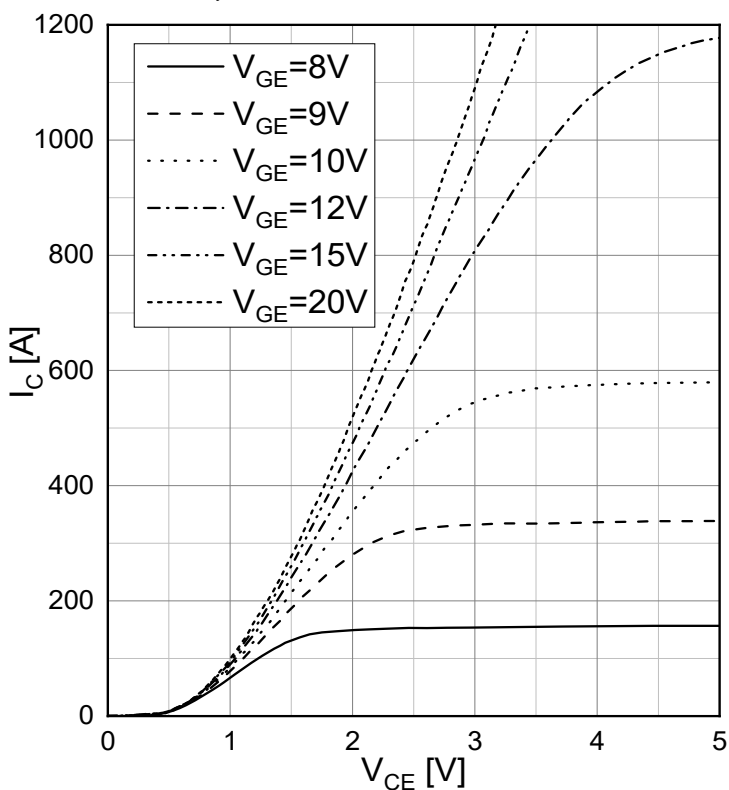

传输特性 IGBT
Transfer Characteristic IGBT
 $I_C = f(V_{GE}), V_{CE} = 20V$

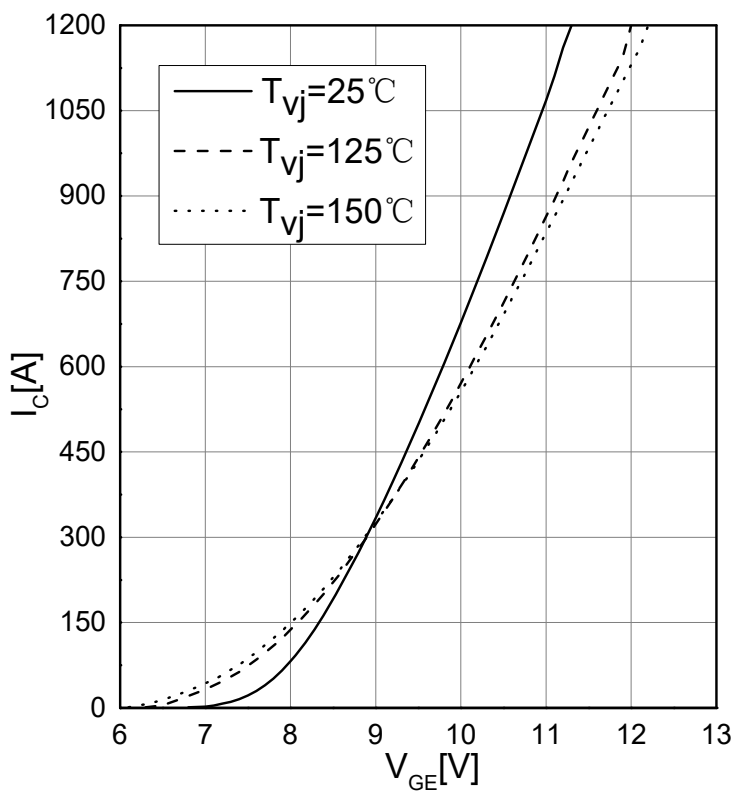

开关损耗 IGBT
Switching Losses IGBT
 $E = f(I_C), V_{GE} = \pm 15V, R_{Gon} = R_{Goff} = 1.1\Omega, V_{CE} = 900V$

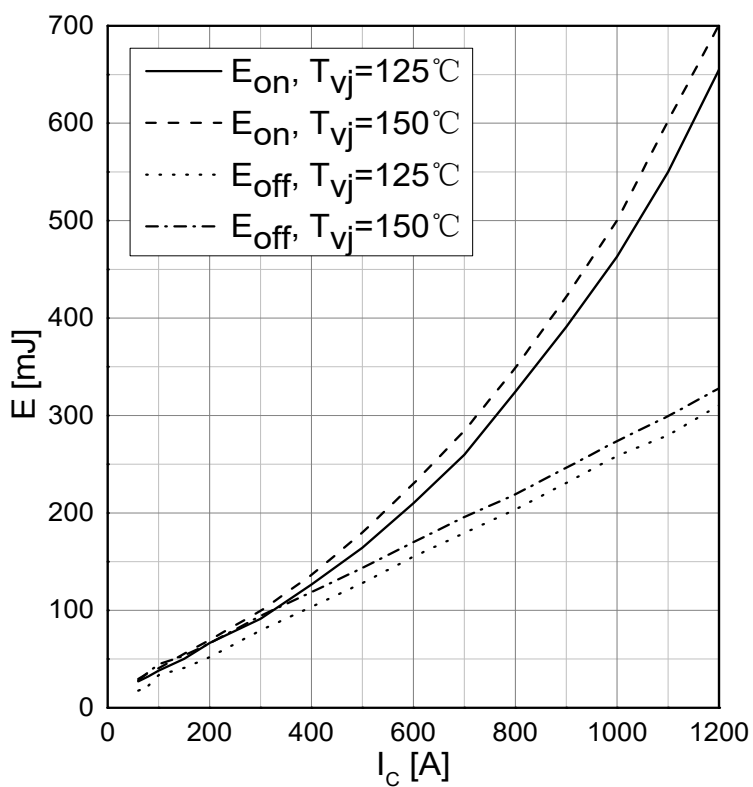

开关损耗IGBT
Switching Losses IGBT
 $V_{GE}=\pm 15V, I_C=600A, V_{CE}=900V$

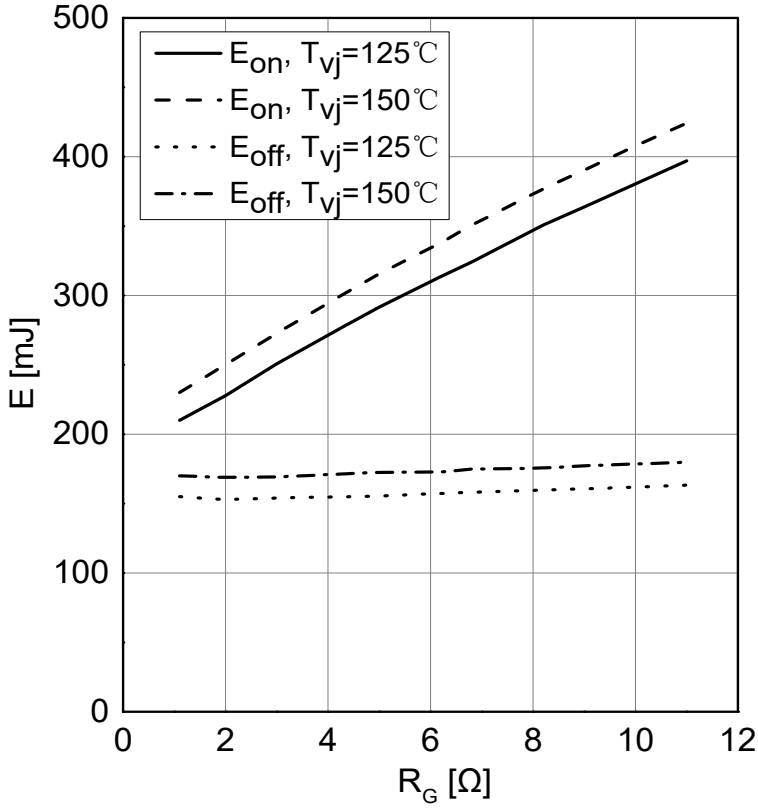

反偏安全工作区 IGBT
Reverse Bias Safe Operating Area IGBT
 $V_{GE}=\pm 15V, R_{Goff}=1.1\Omega, T_{vj}=150^\circ C$

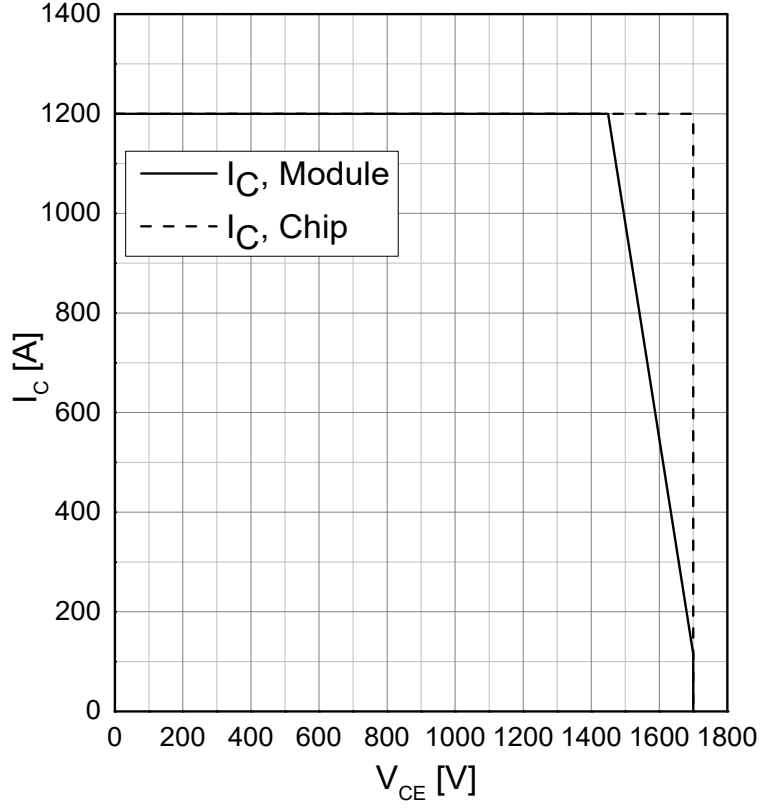

正向特性FRD
Forward Characteristic FRD
 $I_F=f(V_F)$

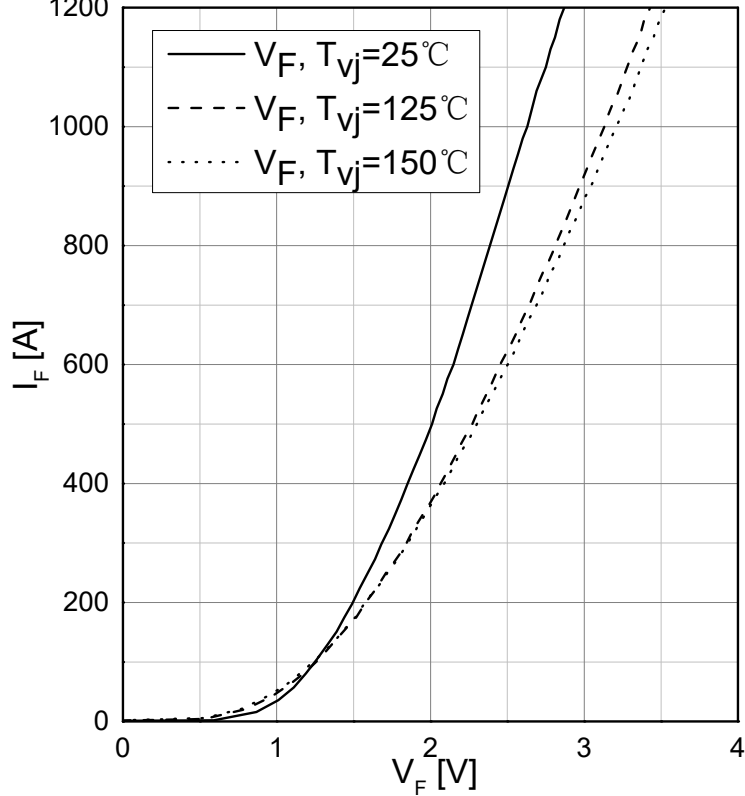

开关损耗 Diode
Switching Losses Diode
 $E_{rec}=f(I_F), R_{Gon}=1.1\Omega, V_{CE}=900V$

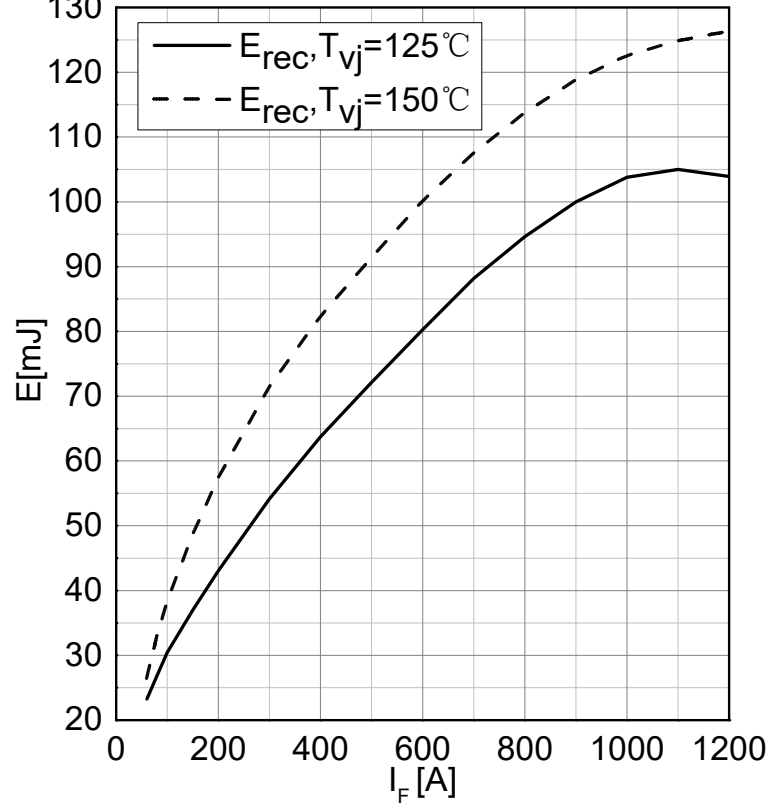

开关损耗Diode
Switching Losses Diode
 $E_{rec}=f(R_G), V_{CE}=900V$

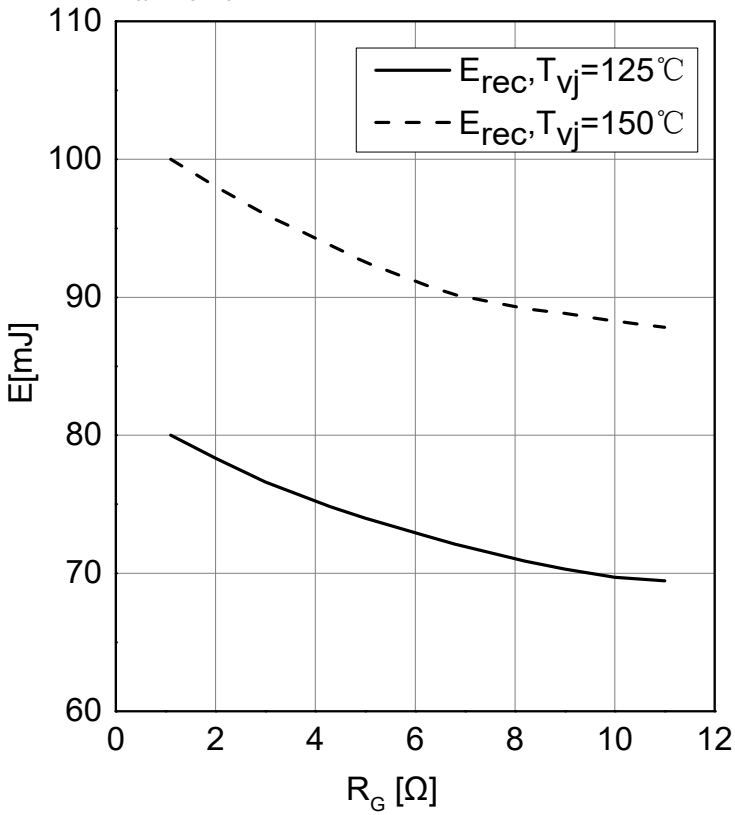

热敏电阻温度特性曲线
NTC Temperature Characteristic

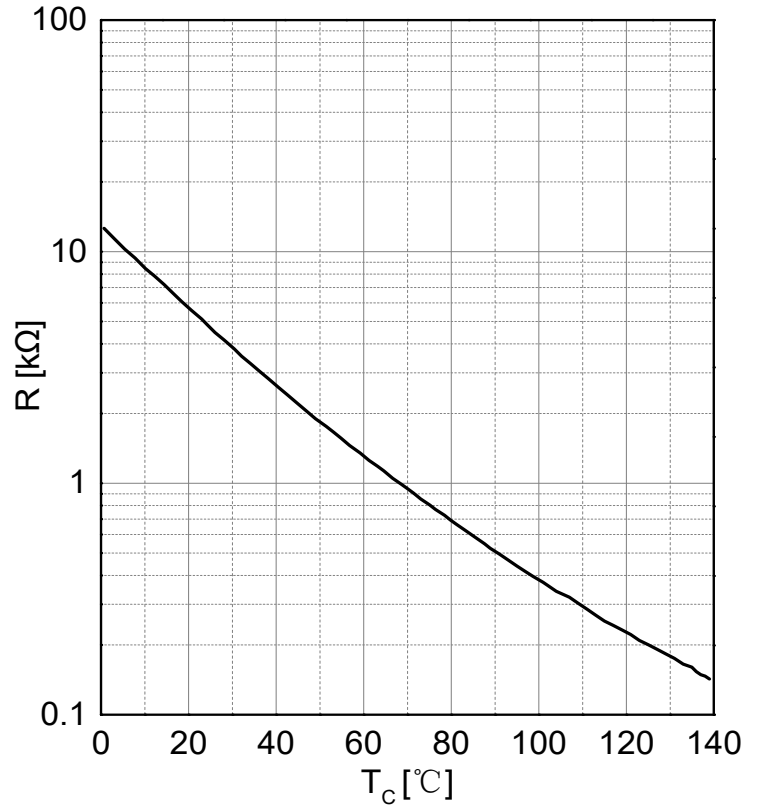

瞬态热阻抗 IGBT
Transient Thermal Impedance IGBT
 $Z_{th(j-c)}=f(t)$

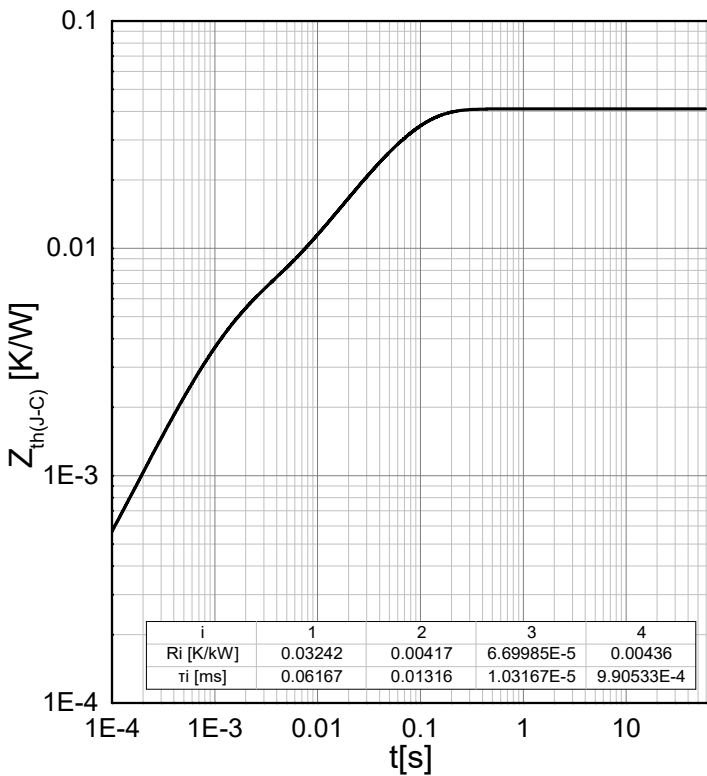

瞬态热阻抗 二极管
Transient Thermal Impedance Diode
 $Z_{th(j-c)}=f(t)$

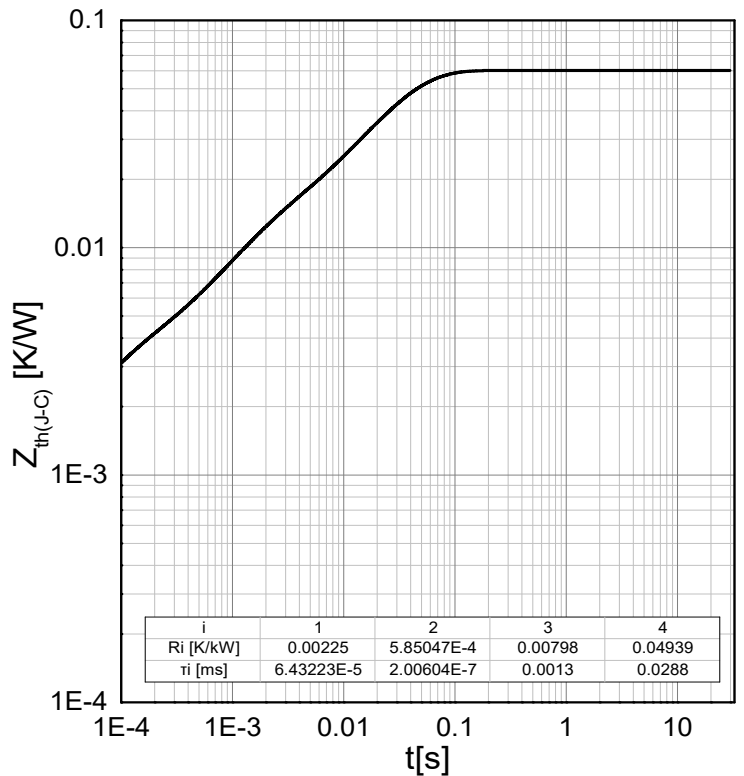

电路图 Circuit Diagram

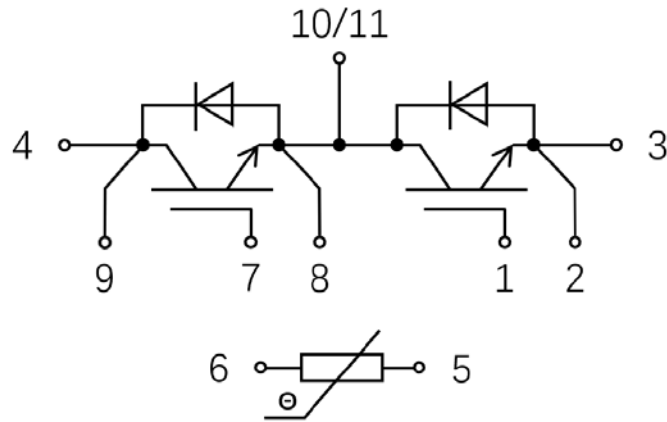

外形尺寸 Outline Drawing

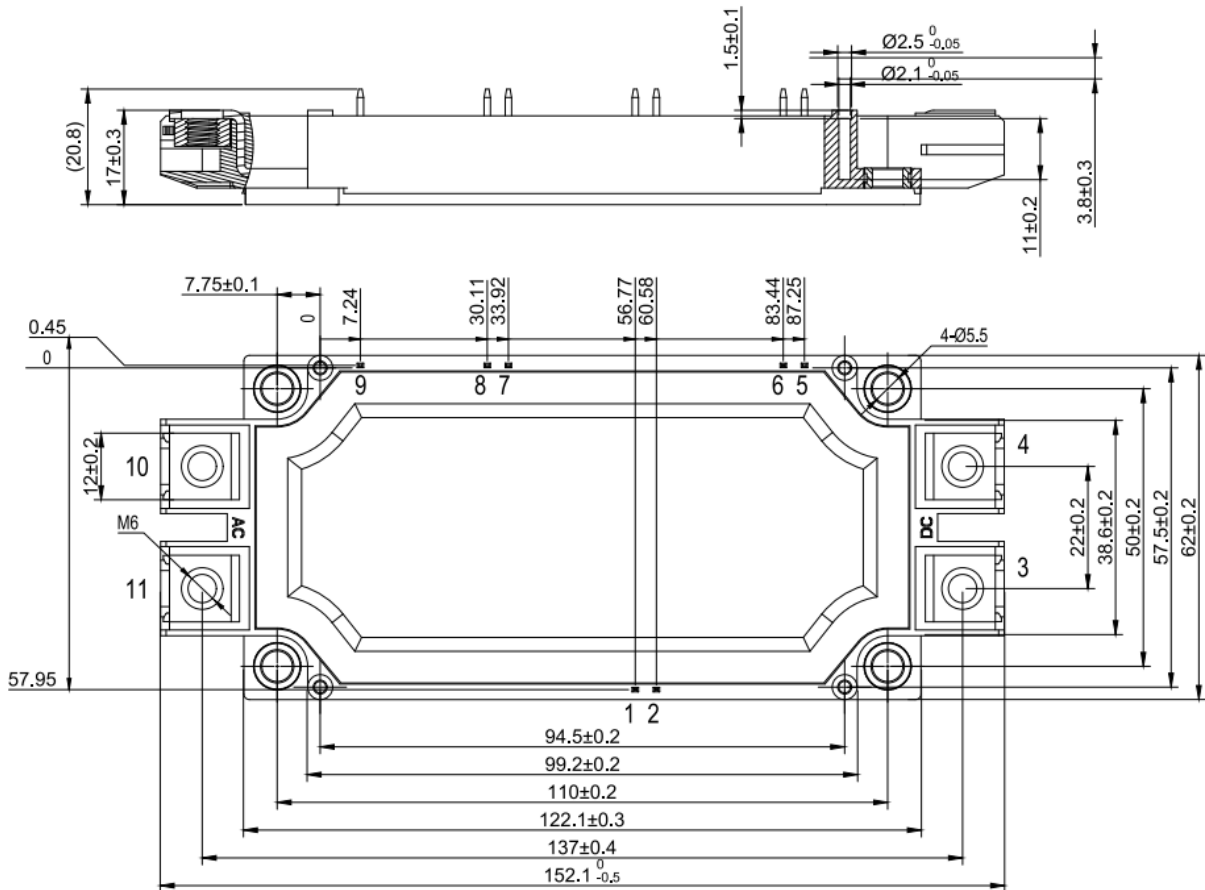

修订记录 Revision History

版本 Version	日期 Date	描述 Description
A0	2022-08-17	初版
A1	2023-01-13	正式版